

SOLEIL

COLLECTION

**INSTALLATION INSTRUCTIONS
PORCELAIN UNDERMOUNT BATHROOM SINKS**

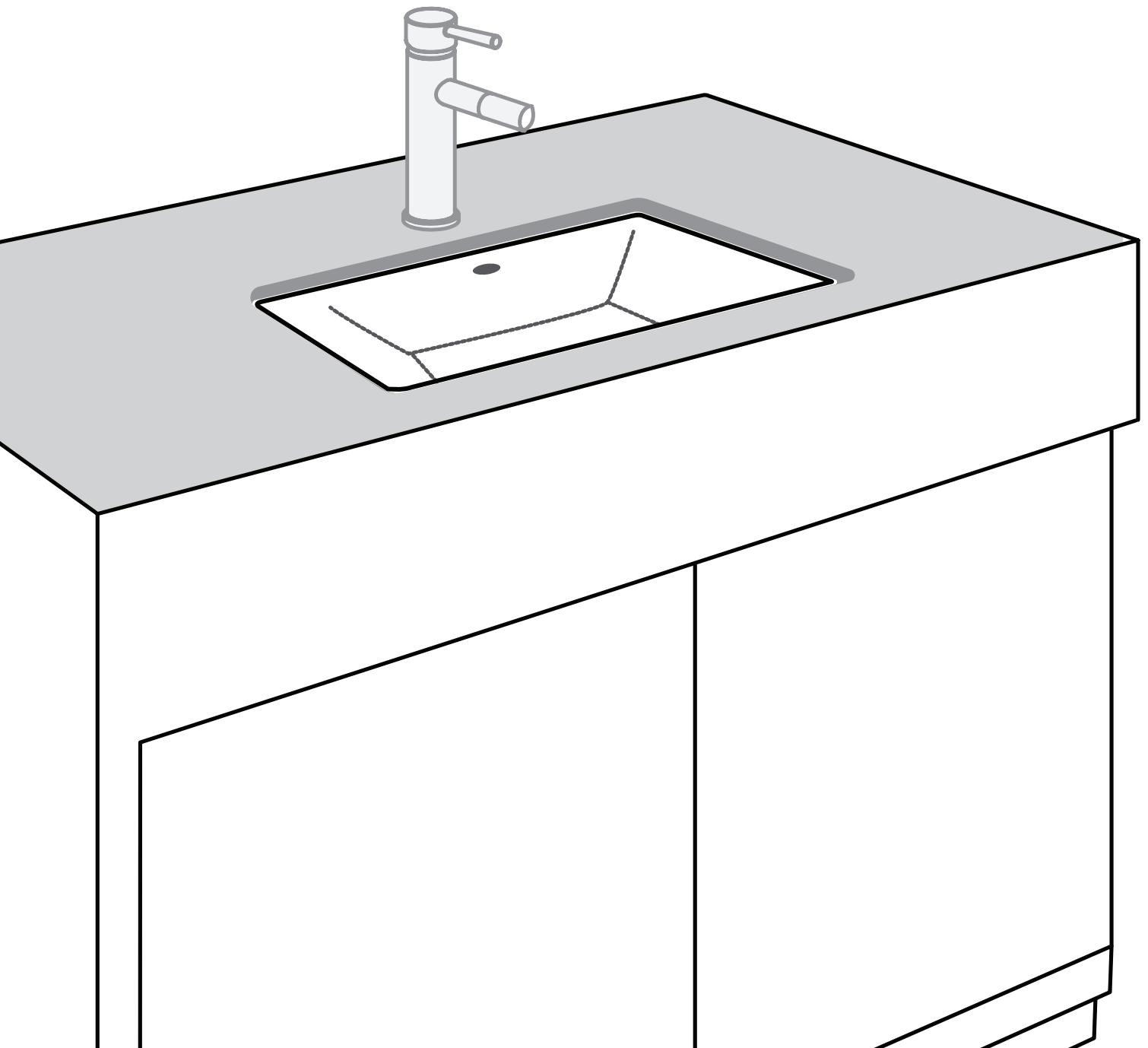



CAUTION:

Risk of personal injury or product damage. Handle with care.
Product can break, chip, cause injury or product damage.

WARNING:

This product can expose you to chemicals, including lead, which is known to the state of California to cause cancer and birth defects or other reproductive harm.

For more information go to p65warnings.ca.gov

IMPORTANT INFORMATION

- Read these instructions carefully before you begin this installation.
- Observe all applicable local plumbing and building codes.
- Soleil Sinks recommends all sinks are installed by experienced and professional installers. To ensure safety and damage-free installation, this sink should be installed by two people. Soleil Sinks reserves the right to revise the design of products without notice.

BEFORE YOU BEGIN

- Soleil Sinks recommends that all porcelain sinks be installed by an experienced, professional installer.
- *IMPORTANT: The enclosed cutout template will create a countertop opening with a minimal (1/8" or less) reveal. It is recommended that you discuss with your installer and agree that the finished appearance is the desired effect. Soleil Sinks not responsible for improper sink or countertop installations.*
- *IMPORTANT: The cabinet must be installed, secured, plumb, and level. Failure of this step can lead to product damage.*
- Soleil Sinks ceramic sinks should only be fastened to a solid surface countertop (i.e. granite, Corian® or Silestone®).
- Soleil Sinks is not responsible for sink or countertop if damaged during installation. Be sure to inspect the sink for damage prior to beginning installation.
- Ceramic edges may be sharp – use caution when handling.
- Follow all local plumbing and building codes.

RECOMMENDED TOOLS

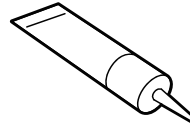
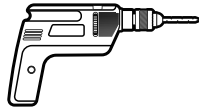
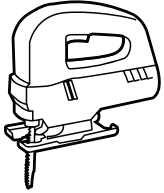
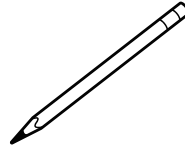
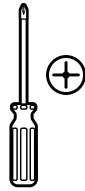
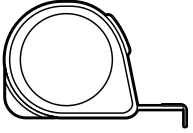

- Tape Measure
- Safety Glasses
- Painter's Tape
- Level
- Ear Protection
- Hacksaw/Jigsaw
- Pencil (Not permanent marker)
- Shims or Cabinet Fillers
- Denatured Alcohol
- Clamps
- Construction Adhesive
- Silicone Adhesive Sealant
- Support Framing Material (1 ¼" (32mm) Max Thickness)
- Screws (recommended by countertop manufacturer)

PORCELAIN SINK INSTALLATION INSTRUCTIONS

1. Unpack the new sink and check the contents of the materials supplied: sink, mounting brackets and cutout template.
2. Cut out the appropriate template for your sink model and desired installation option. Place template in desired position on countertop, locating center of the bowl over cabinet and faucet holes.
3. Trace the outline of the template and cut countertop along the inside of the line using the appropriate cutting tools. The template should be used as a guide only. Use the physical sink to ensure accuracy of the cutout opening.
4. Locate and drill holes on the underside of the countertop, approximately 1" from the edge of the sink, to be installed. Holes should be evenly spaced, approximately 6" - 8" apart, starting from every corner. It is recommended to install a faucet at this point before installing the sink.
5. Loosely attach mounting brackets to the countertop, parallel to the cutout opening, using the mounting screws and butterfly nuts.
6. Clean sink flange and underside of cutout area of countertop, making sure that the area is smooth and free from grease. Apply a continuous bead of silicone caulk evenly on top of the sink flange.
7. Position and align sink over the countertop opening and press sink onto countertop. Turn the bent end of the mounting bracket so that it fits snugly over the sink rim.
8. Check alignment of the sink again and tighten fasteners to secure the sink.
9. Wipe away excess silicone caulk with a damp cloth. Connect drain and water supply according to the manufacturer's instructions.