

SOLEIL

COLLECTION

**INSTALLATION INSTRUCTIONS
SHOWER DRAIN**

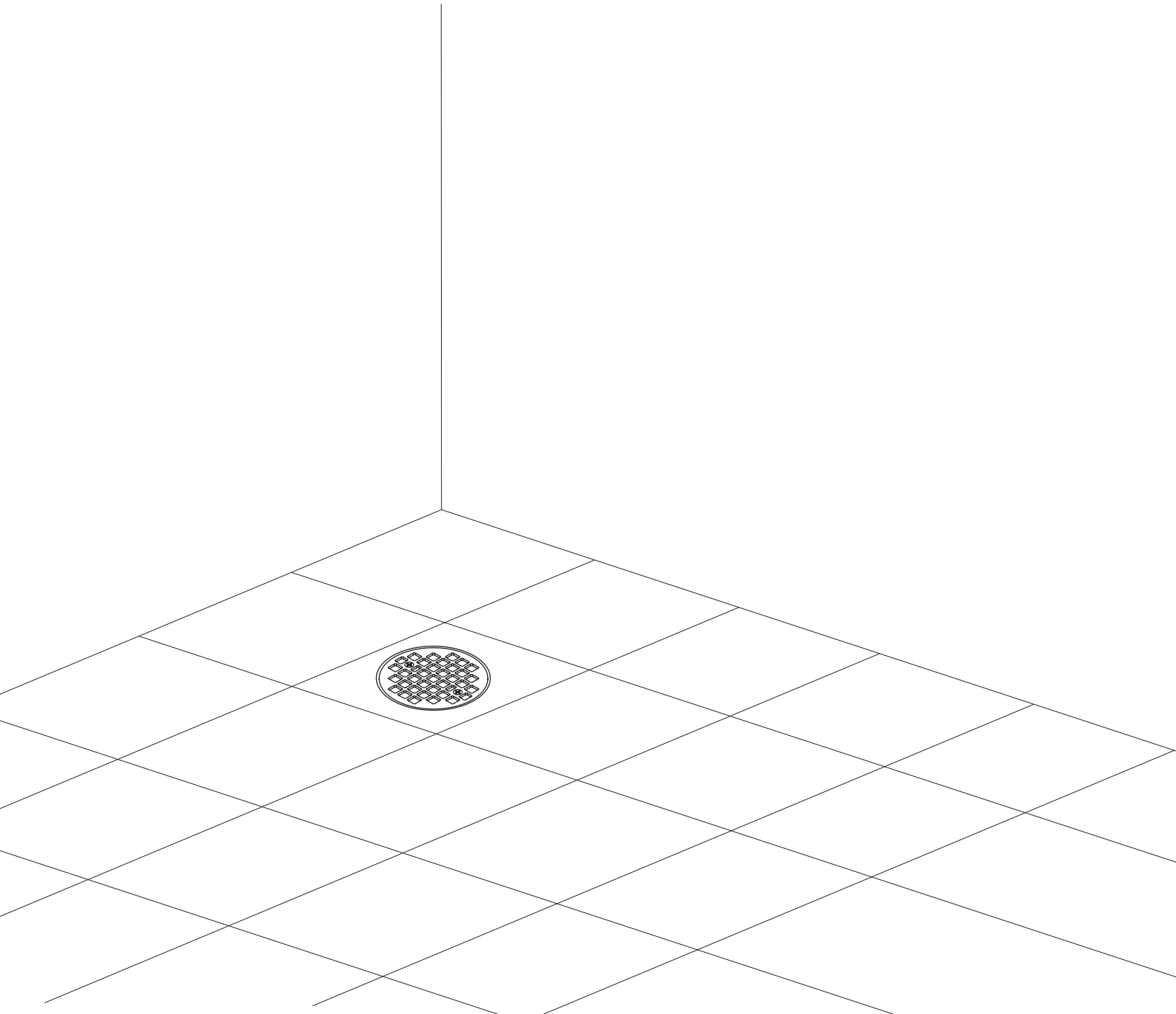



CAUTION:

Risk of personal injury or product damage. Handle with care.
Product can break, chip, cause injury or product damage.

WARNING:

This product can expose you to chemicals, including lead, which is known to the state of California to cause cancer and birth defects or other reproductive harm.

For more information go to p65warnings.ca.gov

IMPORTANT INFORMATION

- Read these instructions carefully before you begin this installation.
- Observe all applicable local plumbing and building codes.
- Soleil Sinks recommends all sinks are installed by experienced and professional installers. Soleil Sinks reserves the right to revise the design of products without notice.

BEFORE YOU BEGIN

- Soleil Sinks recommends that all linear drain should be installed by an experienced, professional installer.
- Soleil Sinks is not responsible for linear drain if damaged during installation. Be sure to inspect the linear drain for damage prior to beginning installation.
- Metal edges may be sharp – use caution when handling.
- Follow all local plumbing and building codes.

RECOMMENDED TOOLS

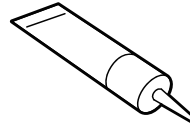
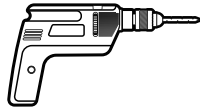
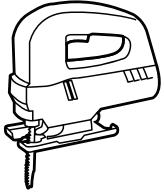
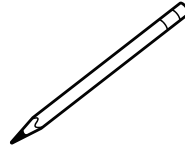
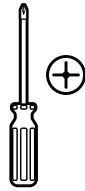
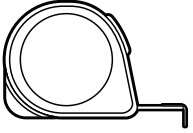

- Tape Measure
- Safety Glasses
- Painter's Tape
- Level
- Ear Protection
- Hacksaw/Jigsaw
- Pencil (Not permanent marker)
- Shims or Cabinet Fillers
- Denatured Alcohol
- Clamps
- Construction Adhesive
- Silicone Adhesive Sealant
- Support Framing Material (1 ¼" (32mm) Max Thickness)
- Screws (recommended by countertop manufacturer)

SHOWER DRAIN INSTALLATION INSTRUCTIONS

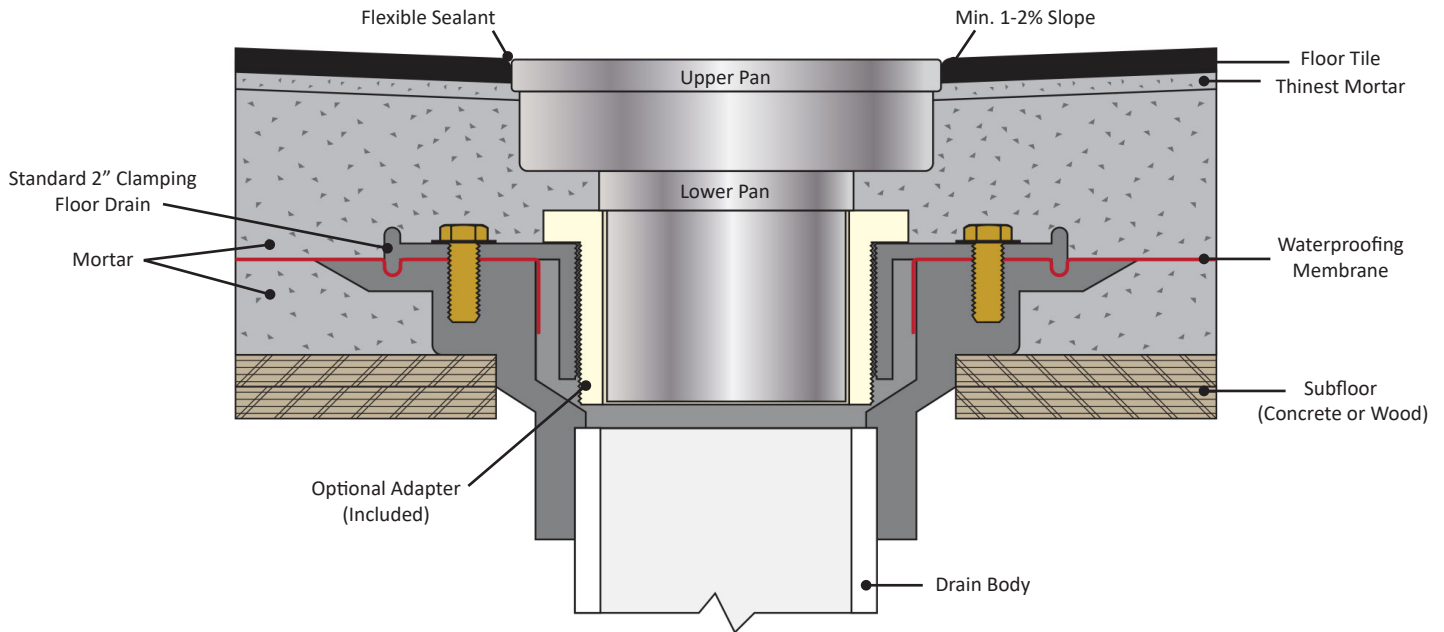

STEP 1: SHOWER FLOOR PREPARATION

- Pre-slope shower pan and install waterproofing membrane per manufacturer's instructions. Any waterproofing membrane material or procedure can be used (vinyl, CPE Membrane, Roll/Paint On, Metal Pan, Hot Mop, Surface Sheet Membrane, etc.). Perform a leak test as required.

STEP 2: LOWER PAN INSTALL

- Place the lower pan (larger drain hole) in the floor drain/drain barrel. If the floor drain is too large to hold the lower pan. A flexible sealant must be applied between the lower pan and floor tiles to ensure a proper seal.

STEP 3: UPPER PAN INSTALL

- Lower pan to complete the project. Install the chosen tile onto the upper pan grate as desired. Once this is complete, the upper pan can be placed into the lower pan to complete the project.